

## DS-2CE56D0T-IT1F (C) 2 MP Camera



- 2 MP, 1920 × 1080 resolution
- 2.8 mm, 3.6 mm, 6 mm fixed focal lens
- 4 in 1 video output (switchable TVI/AHD/CVI/CVBS)
- Smart IR, up to 30 m IR distance
- IP67



## Specification

Camera	
Image Sensor	2 MP CMOS
Signal System	PAL/NTSC
Resolution	1920 (H) × 1080 (V)
Frame Rate	TVI: 1080P@30fps, 1080P@25fps CVI: 1080P@30fps, 1080P@25fps AHD: 1080P@30fps, 1080P@25fps CVBS: PAL/NTSC
Min. illumination	0.01 Lux@(F1.2, AGC ON), 0 Lux with IR
Shutter Time	PAL: 1/25 s to 1/50, 000 s NTSC: 1/30 s to 1/50, 000 s
Lens	2.8 mm, 3.6 mm, 6 mm fixed lens
Field of View	2.8 mm, horizontal FOV: 101°, vertical FOV: 60°, diagonal FOV: 122° 3.6 mm, horizontal FOV: 79.6°, vertical FOV: 43.5°, diagonal FOV: 93.7° 6 mm, horizontal FOV: 51.9°, vertical FOV: 30°, diagonal FOV: 58.8°
Lens Mount	M12
Day & Night	ICR
WDR (Wide Dynamic Range)	Digital WDR
Angle Adjustment	Pan: 0 to 360°, Tilt: 0 to 75°, Rotation: 0 to 360°
Menu	
Image Mode	STD/HIGH-SAT
AGC	Yes
Day/Night Mode	Auto/Color/BW (Black and White)
White Balance	Auto/Manual
AE (Auto Exposure) Mode	DWDR/BLC/HLC/Global
Noise Reduction	2D DNR
Language	English
Function	Brightness, Sharpness, Smart IR
Interface	
Video Output	Switchable TVI/AHD/CVI/CVBS
General	
Operating Conditions	-40 °C to 60 °C (-40 °F to 140 °F), humidity 90% or less (non-condensing)
Power Supply	12 VDC ± 25%
Power Consumption	Max. 2.2 W
Protection Level	IP67
Material	Plastic
IR Range	Up to 30 m
Communication	HIKVISION-C

General	
Dimensions	Φ 110 mm × 93.2 mm (Φ 4.33" × 3.67")
Weight	Approx. 211 g (0.47 lb.)

**Available Model**

DS-2CE56D0T-IT1F (C)

**Dimension**

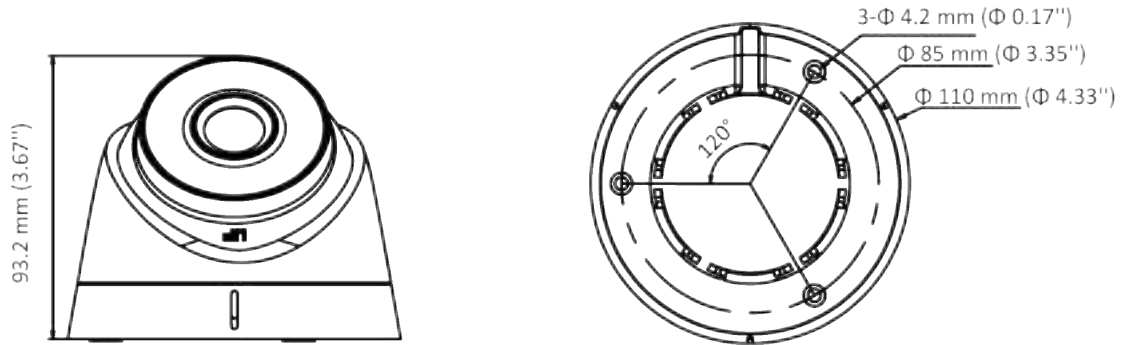

**Accessory**

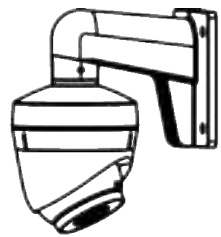

**DS-1272ZJ-110-TRS**  
Wall Mount

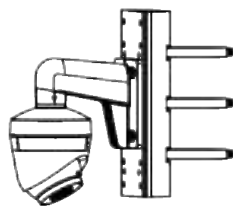

**DS-1275ZJ-SUS**  
Vertical Pole Mount

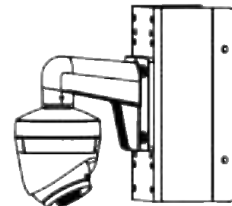

**DS-1276ZJ-SUS**  
Corner Mount

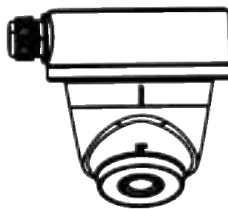

**DS-1280ZJ-S**  
Junction Box

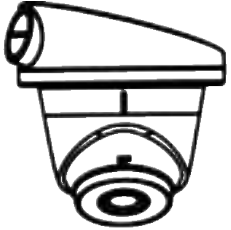

**DS-1281ZJ-S**  
Inclined Ceiling Mount

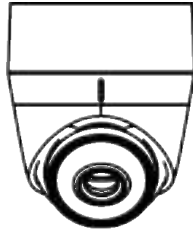

**DS-1280ZJ-TR13**  
Junction Box

Distributed by



## HIKVISION

### Headquarters

No.555 Qianmo Road, Binjiang District,  
Hangzhou 310052, China  
T +86-571-8007-5998  
ovarsaasbusiness@hikvision.com

**Hikvision USA**  
T +1-909-805-0400  
sales.usa@hikvision.com

**Hikvision Australia**  
T +61-2-8589-4233  
salesau@hikvision.com

**Hikvision India**  
T +91-22-28469000  
sales@pramahikvision.com

**Hikvision Canada**  
T +1-866-200-6690  
sales.canada@hikvision.com

**Hikvision Thailand**  
T +662-275-8949  
sales.thailand@hikvision.com

**Hikvision Europe**  
T +31-23-5542770  
sales.eu@hikvision.com

**Hikvision Italy**  
T +39-0438-6902  
info.it@hikvision.com

**Hikvision Brazil**  
T +55-11-3318-0050  
latam.support@hikvision.com

**Hikvision Turkey**  
T +90-2164521-7070-7074  
sales.tr@hikvision.com

**Hikvision Malaysia**  
T +601-7652-2413  
sales.my@hikvision.com

**Hikvision UK & Ireland**  
T +01628-502140  
sales.uk@hikvision.com

**Hikvision South Africa**  
Tel: +27 (0) 0361172  
sale.africa@hikvision.com

**Hikvision France**  
T +33(0)1-85-330-450  
info.fr@hikvision.com

**Hikvision Kazakhstan**  
T +7-727-9730667  
nikla.ponfilov@hikvision.ru

**Hikvision Vietnam**  
T +84-974270888  
sales.vt@hikvision.com

**Hikvision UAE**  
T +971-4-4432050  
sales.me@hikvision.com

**Hikvision Singapore**  
T +65-6884-4718  
sg@hikvision.com

**Hikvision Spain**  
T +34-93-737-18-55  
info.es@hikvision.com

**Hikvision Tashkent**  
T +99-67-1218-9438  
uzb@hikvision.ru

**Hikvision Hong Kong**  
T +852-2151-1761  
info.hk@hikvision.com

**Hikvision Russia**  
T +7-495-589-67-89  
salaru@hikvision.com

**Hikvision Korea**  
T +82-0031-731-8817  
sales.korea@hikvision.com

**Hikvision Poland**  
T +48-22-460-01-50  
info.pl@hikvision.com

**Hikvision Indonesia**  
T +62-21-2933759  
Sales.Indonesia@hikvision.com

**Hikvision Colombia**  
sales.colombia@hikvision.com