

DS-7608NXI-K2

8-ch 1U K Series AcuSense 4K NVR

Key Feature

- Up to 8-ch IP camera inputs
- H.265+/H.265/H.264+/H.264 video formats
- Up to 2-ch@12 MP or 3-ch@8 MP or 6-ch@4 MP or 12-ch@1080p decoding capacity
- Up to 80 Mbps incoming bandwidth
- Adopt Hikvision Acusense technology to minimize manual effort and security costs



Smart Function

- All channels support Motion Detection 2.0
- 2-ch video analysis for human and vehicle recognition to reduce false alarm
- 1-ch facial recognition for video stream, or 4-ch facial recognition for face picture
- Smart search for the selected area in the video, and smart playback to improve the playback efficiency

Professional and Reliability

- H.265+ compression effectively reduces the storage space by up to 75%
- Adopt stream over TLS encryption technology which provides more secure stream transmission service

HD Video Output

- Provide independent HDMI and VGA outputs
- HDMI video output at up to 4K resolution

Storage and Playback

- Up to 2 SATA interfaces for HDD connection (up to 10 TB capacity per HDD)
- 8-ch synchronous playback

Network & Ethernet Access

- 1 self-adaptive 10/100/1000 Mbps Ethernet interface
- Hik-Connect for easy network management

▪ Specification

Intelligent Analytics	
AI by Device	Facial recognition, perimeter protection, motion detection 2.0
AI by Camera	Facial recognition, perimeter protection, throwing objects from building, motion detection 2.0, ANPR, VCA
Facial Recognition	
Facial Detection and Analytics	Face picture comparison, human face capture, face picture search
Face Picture Library	Up to 16 face picture libraries, with up to 20,000 face pictures in total (each picture ≤ 4 MB, total capacity ≤ 1 GB)
Facial Detection and Analytics Performance	1-ch, 8 MP
Face Picture Comparison	4-ch
Motion Detection 2.0	
By Device	All channels, 4 MP (when enhanced SVC mode is enabled, up to 8 MP) video analysis for human and vehicle recognition to reduce false alarm
By Camera	All channels
Perimeter Protection	
By Device	2-ch, 4 MP (HD network camera, H.264/H.265) video analysis for human and vehicle recognition to reduce false alarm
By Camera	All channels
Video and Audio	
IP Video Input	8-ch
Incoming Bandwidth	80 Mbps
Outgoing Bandwidth	160 Mbps
HDMI Output	1-ch, 4K (3840 × 2160)/30 Hz, 2K (2560 × 1440)/60 Hz, 1920 × 1080/60 Hz, 1600 × 1200/60 Hz, 1280 × 1024/60 Hz, 1280 × 720/60 Hz, 1024 × 768/60 Hz
VGA Output	1-ch, 1920 × 1080/60 Hz, 1280 × 1024/60 Hz, 1280 × 720/60 Hz
Video Output Mode	HDMI/VGA independent output
CVBS Output	N/A
Audio Output	1-ch, RCA (2.0 Vp-p, 1 KΩ, using the audio input)
Two-Way Audio	1-ch, RCA (Linear, 1 KΩ)
Decoding	
Decoding Format	H.265/H.265+/H.264+/H.264
Recording Resolution	12 MP/8 MP/6 MP/5 MP/4 MP/3 MP/1080p/UXGA/720p/VGA/4CIF/DCIF/2CIF/CIF/QCIF
Synchronous playback	8-ch

Decoding Capability	AI on: 1-ch@12 MP (30 fps)/2-ch@8 MP (30 fps)/4-ch@4 MP (30 fps)/8-ch@1080p (30 fps) AI off: 2-ch@12 MP (30 fps)/3-ch@8 MP (30 fps)/6-ch@4 MP (30 fps)/12-ch@1080p (30 fps)
Stream Type	Video, Video & Audio
Audio Compression	G.711ulaw/G.711alaw/G.722/G.726/AAC
Network	
Remote Connection	128
API	ONVIF (profile S/G); SDK; ISAPI
Compatible Browser	IE11, Chrome V57, Firefox V52, Safari V12, Edge V89, or above version
Network Protocol	TCP/IP, DHCP, IPv4, IPv6, DNS, DDNS, NTP, RTSP, SADP, SMTP, SNMP, NFS, iSCSI, ISUP, UPnP™, HTTP, HTTPS
Network Interface	1 RJ-45 10/100/1000 Mbps self-adaptive Ethernet interface
Auxiliary Interface	
SATA	2 SATA interfaces
Capacity	Up to 10 TB capacity for each HDD
USB Interface	Front panel: 1 × USB 2.0; Rear panel: 1 × USB 2.0
Alarm In/Out	4/1
General	
GUI Language	English, Russian, Bulgarian, Hungarian, Greek, German, Italian, Czech, Slovak, French, Polish, Dutch, Portuguese, Spanish, Romanian, Turkish, Japanese, Danish, Swedish Language, Norwegian, Finnish, Korean, Traditional Chinese, Thai, Estonian, Vietnamese, Croatian, Slovenian, Serbian, Latvian, Lithuanian, Uzbek, Kazakh, Arabic, Ukrainian, Kyrgyz, Brazilian Portuguese, Indonesian
Power Supply	12 VDC, 3.3 A
Consumption	≤ 15 W (without HDD)
Working Temperature	-10 °C to 55 °C (14 °F to 131 °F)
Working Humidity	10% to 90%
Dimension (W × D × H)	385 mm × 315 mm × 52 mm (15.2" × 12.4" × 2.0")
Weight	≤ 1 kg (without HDD, 2.2 lb.)
Certification	
FCC	Part 15 Subpart B, ANSI C63.4-2014
CE	EN 55032: 2015, EN 61000-3-2, EN 61000-3-3, EN 50130-4, EN 55035: 2017
Obtained Certification	CE, FCC, IC, CB, KC, UL, Rohs, Reach, WEEE, RCM, UKCA, LOA, BIS

Note:

Facial recognition, motion detection 2.0 or perimeter protection cannot be enabled at the same time.

Dimension

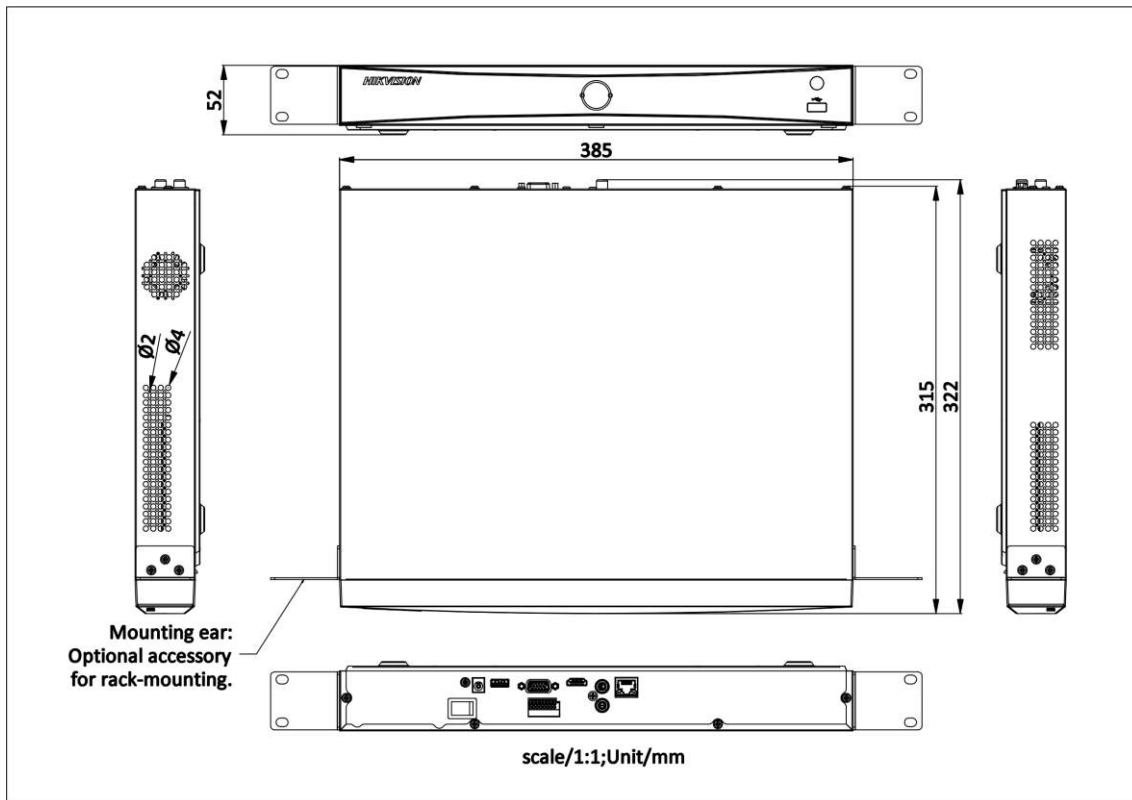

Physical Interface

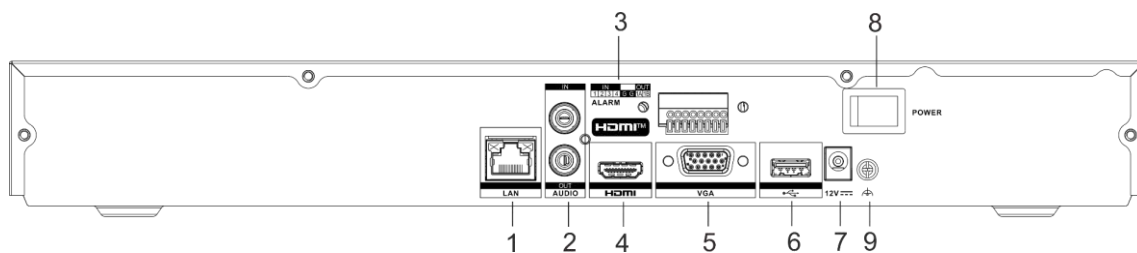

No.	Description	No.	Description
1	LAN network interface	6	USB interface
2	AUDIO IN and AUDIO OUT	7	Power supply
3	ALARM IN and ALARM OUT	8	Power switch
4	HDMI interface	9	GND
5	VGA interface		

Available Model

DS-7608NXI-K2

Headquarters

No.555 Qianmo Road, Binjiang District,
Hangzhou 310051, China
T: +86-573-8807-6888
www.hikvision.com

Follow us on social media to get the latest product and solution information.

