

DS-7604NXI-K1/4P

4-ch PoE 1U K Series AcuSense 4K NVR

Key Feature

- Up to 4-ch IP camera inputs, plug & play with 4 power-over-Ethernet (PoE) interfaces
- H.265+/H.265/H.264+/H.264 video formats
- Up to 1-ch@12 MP or 2-ch@8 MP or 4-ch@4 MP or 8-ch@1080p decoding capacity
- Up to 40 Mbps incoming bandwidth
- Adopt Hikvision Acusense technology to minimize manual effort and security costs



Smart Function

- 1-ch facial recognition for video stream, or 2-ch facial recognition for face picture
- Smart search for the selected area in the video, and smart playback to improve the playback efficiency

Professional and Reliability

- H.265+ compression effectively reduces the storage space by up to 75%
- Adopt stream over TLS encryption technology which provides more secure stream transmission service

HD Video Output

- Provide simultaneous HDMI and VGA outputs
- HDMI video output at up to 4K resolution

Storage and Playback

- Up to 1 SATA interface for HDD connection (up to 10 TB)
- 4-ch synchronous playback

Network & Ethernet Access

- 4 independent PoE network interfaces
- 1 self-adaptive 10/100 Mbps Ethernet interface
- Hik-Connect for easy network management

▪ Specification

Intelligent Analytics	
AI by Device	Facial recognition, perimeter protection, motion detection
AI by Camera	Facial recognition, perimeter protection, throwing objects from building, motion detection2.0, ANPR, VCA
Facial Recognition	
Face Attributes	N/A
Facial Detection and Analytics	Face picture comparison, human face capture, face picture search
Face Picture Library	Up to 16 face picture libraries, with up to 5,000 face pictures in total (each picture ≤ 1MB, total capacity ≤ 73MB)
Facial Detection and Analytics Performance	1-ch, 4 MP
Face Picture Comparison (Captured from Camera)	2-ch
Motion Detection 2.0	
By Device	All channels, 4 MP (when enhanced SVC mode is enabled, up to 8 MP) video analysis for human and vehicle recognition to reduce false alarm
By Camera	All channels
Perimeter Protection	
By Device	1-ch, 4 MP (HD network camera, H.264/H.265) video analysis for human and vehicle recognition to reduce false alarm
By Camera	All channels
Video and Audio	
IP Video Input	4-ch
Incoming Bandwidth	40 Mbps
Outgoing Bandwidth	80 Mbps
HDMI Output	1-ch, 4K (3840 × 2160)/30 Hz, 2K (2560 × 1440)/60 Hz, 1920 × 1080/60 Hz, 1600 × 1200/60 Hz, 1280 × 1024/60 Hz, 1280 × 720/60 Hz
VGA Output	1-ch, 1920 × 1080/60 Hz, 1600 × 1200/60 Hz, 1280 × 1024/60 Hz, 1280 × 720/60 Hz
Video Output Mode	HDMI1/VGA simultaneous output as default, HDMI1/VGA can be set to independent output
CVBS Output	N/A
Audio Output	1-ch, RCA (Linear, 1 KΩ)
Two-Way Audio	1-ch, RCA (2.0 Vp-p, 1 KΩ, using the audio input)
Decoding	
Decoding Format	H.265/H.265+/H.264+/H.264
Recording Resolution	12 MP/8 MP/6 MP/5 MP/4 MP/3 MP/1080p/UXGA/720p/VGA/4CIF/DCIF/2CIF/CIF/QCIF
Synchronous Playback	4-ch
Decoding Capability	AI on: 1-ch@12 MP (30 fps)/1-ch@8 MP (30 fps)/3-ch@4 MP (30 fps)/6-ch@1080p (30 fps) AI off: 1-ch@12 MP (30 fps)/2-ch@8 MP (30 fps)/4-ch@4 MP (30 fps)/8-ch@1080p (30 fps)
Stream Type	Video, Video & Audio

Audio Compression	G.711ulaw/G.711alaw/G.722/G.726/AAC
Network	
Remote Connection	128
API	ONVIF (profile S/G); SDK; ISAPI
Compatible Browser	IE11, Chrome V57, Firefox V52, Safari V12, Edge V89, or above version
Network Protocol	TCP/IP, DHCP, IPv4, IPv6, DNS, DDNS, NTP, RTSP, SADP, SMTP, SNMP, NFS, iSCSI, ISUP, UPnP™, HTTP, HTTPS
Network Interface	1 RJ-45 10/100 Mbps self-adaptive Ethernet interface
PoE	
Interface	4, RJ-45 10/100 Mbps self-adaptive Ethernet interface
Power	≤ 50 W
Standard	IEEE 802.3af/at
Auxiliary Interface	
SATA	1 SATA interface
Capacity	Up to 10 TB capacity for each HDD
USB Interface	Front panel: 1 × USB 2.0; Rear panel: 1 × USB 2.0
Alarm In/Out	N/A (4/1 is optional)
General	
GUI Language	English, Russian, Bulgarian, Hungarian, Greek, German, Italian, Czech, Slovak, French, Polish, Dutch, Portuguese, Spanish, Romanian, Turkish, Japanese, Danish, Swedish Language, Norwegian, Finnish, Korean, Traditional Chinese, Thai, Estonian, Vietnamese, Croatian, Slovenian, Serbian, Latvian, Lithuanian, Uzbek, Kazakh, Arabic, Ukrainian, Kyrgyz , Brazilian Portuguese, Indonesian
Power Supply	48 VDC, 1.35 A
Consumption	≤ 10 W (without HDD and PoE off)
Working Temperature	-10 °C to 55 °C (14 °F to 131 °F)
Working Humidity	10% to 90%
Dimension (W × D × H)	320 mm × 240 mm × 48 mm (12.6"× 9.4" × 1.9")
Weight	≤ 1 kg (without HDD, 2.2 lb.)
Certification	
CE	EN 55032: 2015, EN 61000-3-2, EN 61000-3-3, EN 50130-4, EN 55035: 2017
Obtained Certification	CE, CB, KC, Reach, WEEE, RCM, UKCA, LOA

**Note:*

**Alarm in/out can be optional for certain models. If you select a device model with "/Alarm4+1", then the device will have 4 alarm inputs and 1 alarm outputs.*

▪ Dimension

DS-7604NXI-K1/4P(B):

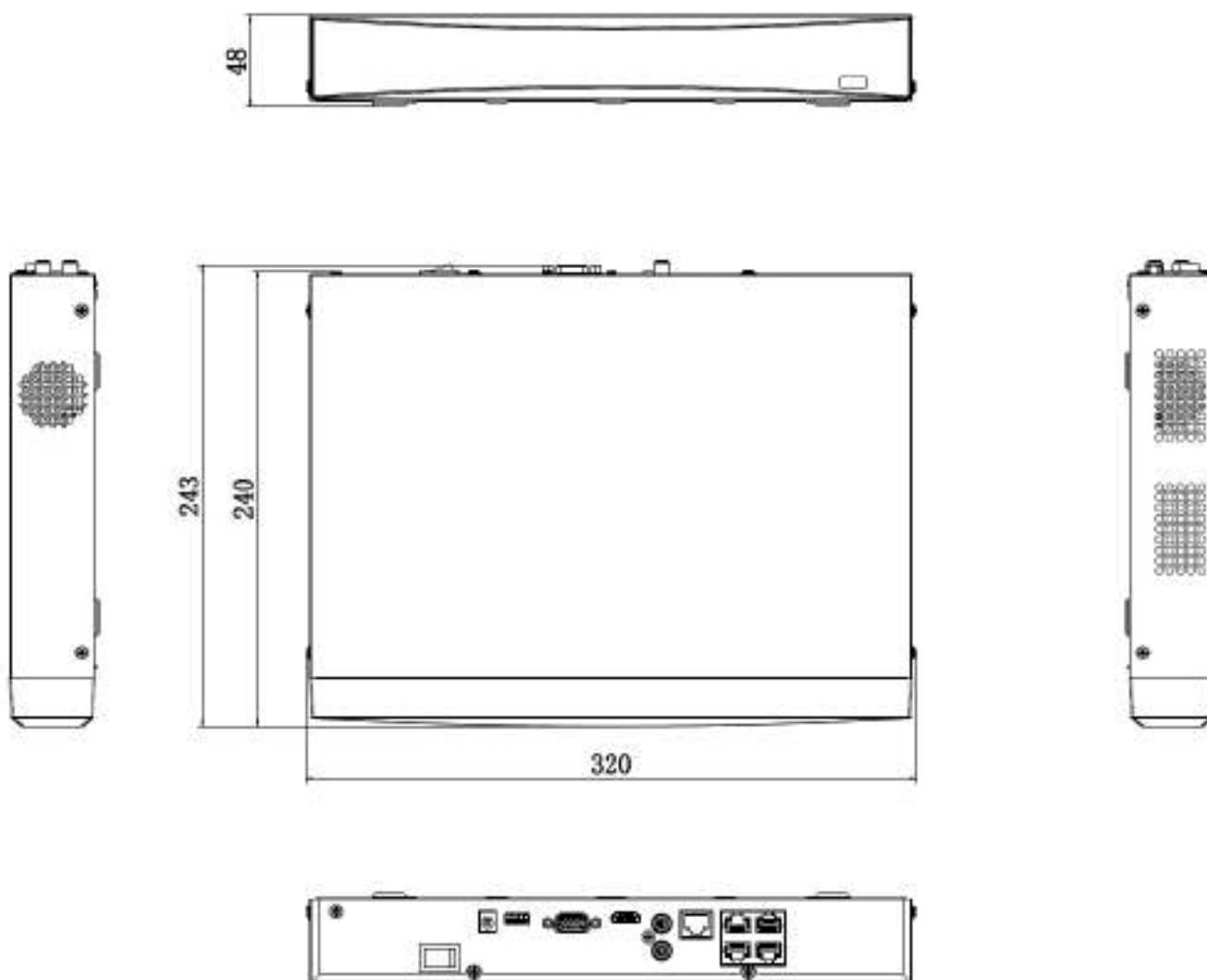

scale/1:1;Unit/mm

DS-7604NXI-K1/4P(B)/Alarm4+1:

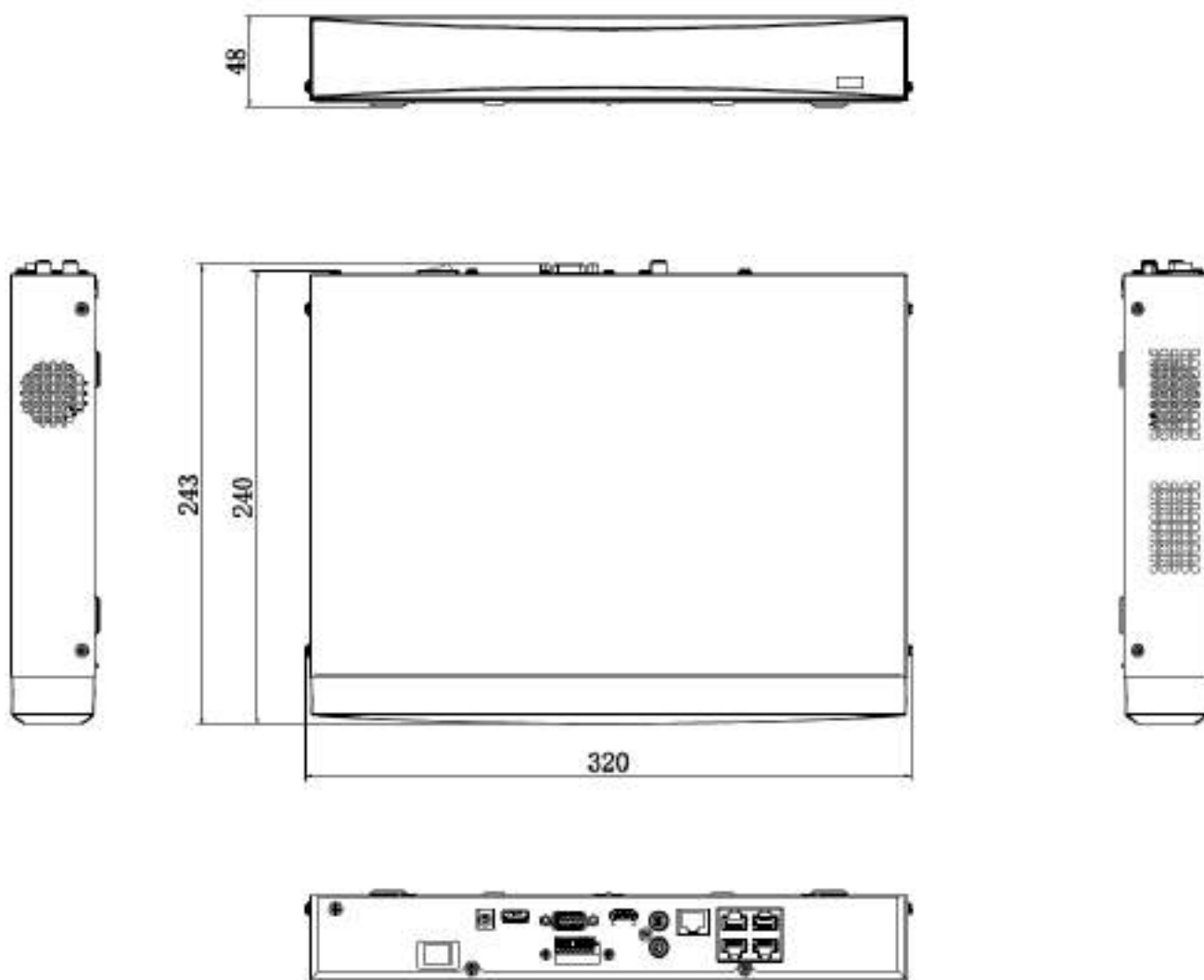

scale/1:1;Unit/mm

Physical Interface

DS-7604NXI-K1/4P(B):

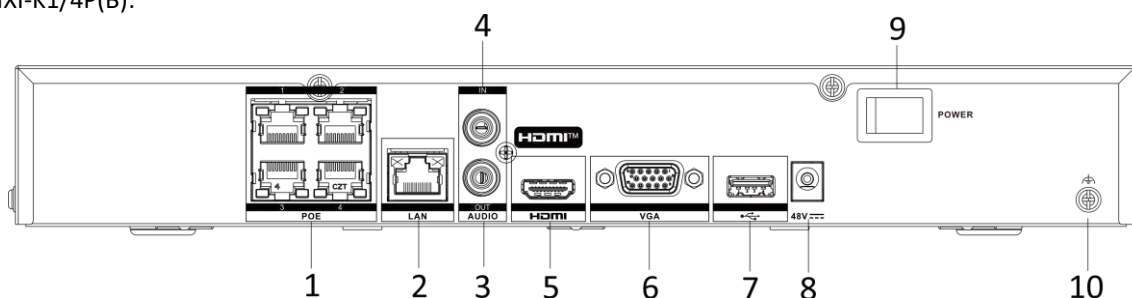

DS-7604NXI-K1/4P(B)/Alarm4+1:

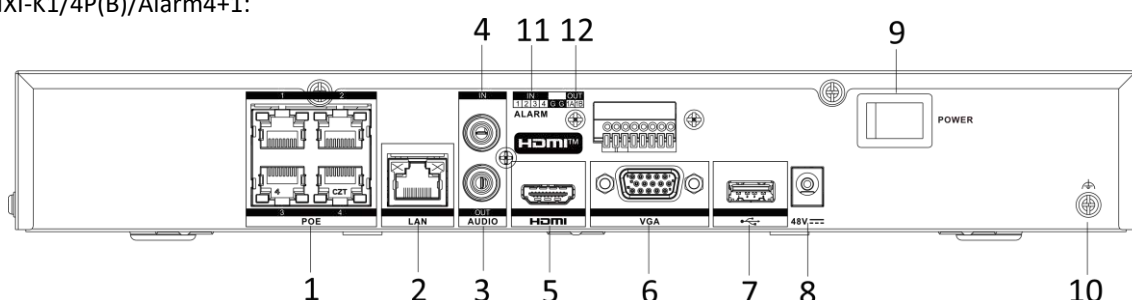

No.	Description	No.	Description
1	Network interfaces with PoE function	7	USB interface
2	LAN network interface	8	Power supply
3	AUDIO OUT	9	Power switch
4	AUDIO IN	10	GND
5	HDMI interface	11	ALARM IN
6	VGA interface	12	ALARM OUT

Available Model

DS-7604NXI-K1/4P(B)

DS-7604NXI-K1/4P(B)/Alarm4+1

Headquarters

No.556 Qianmo Road, Binjiang District,
Hangzhou 310051, China
T +86-571-8817-5998
www.hikvision.com



Follow us on social media to get the latest product and solution information.

