

# DH-HAC-HDW1400TRQ(-A)

## 4MP HDCVI IR Eyeball Camera



- Max 30fps@4MP
- Built-in mic (-A)
- CVI/CVBS/AHD/TVI switchable
- 3.6mm fixed lens (2.8mm optional)
- Max. IR length 25m, Smart IR
- IP50, DC12V



### System Overview

Experience 4MP full HD video and the simplicity of using existing cabling infrastructure with HDCVI. The Lite series 4MP HDCVI camera features a compact design and offers a high quality image at a friendly price. It offers various motorized/fixed lens models with a multi-language OSD and HD/SD switchable output. Its structural flexibility and high cost-performance makes the camera an ideal choice for SMB solutions.

### Functions

#### 4 Signals over 1 Coaxial Cable

HDCVI technology supports 4 signals to be transmitted over 1 coaxial cable simultaneously, i.e. video, audio\*, data and power. Dual-way data transmission allows the HDCVI camera to interact with the XVR, such as sending control signal or triggering alarm. Moreover, HDCVI technology supports PoC for construction flexibility.

\* Audio input is available for some models of HDCVI cameras.

#### Long Distance Transmission

HDCVI technology guarantees real-time transmission at long distance without any loss. It supports up to 700 m for 4MP HD video via coaxial cable, and up to 300 m via UTP cable.\*

\*Actual results verified by real-scene testing in Dahua's test laboratory.

#### Simplicity

HDCVI technology inherits the feature of simplicity from traditional analog surveillance system, making itself a best choice for investment protection. HDCVI system can seamlessly upgrade the traditional analog system without replacing existing coaxial cabling. The plug and play approach enables full HD video surveillance without the hassle of configuring a network.

#### Smart IR

The camera is designed with IR LED illumination for best lowlight performance. Smart IR is a technology that ensures brightness uniformity in B/W image under low illumination. Dahua's unique Smart IR adjusts to the intensity of camera's infrared LEDs to compensate for the distance of an object, and prevents IR LEDs from overexposing images as the object come closer to the camera.

#### Multi-formats

The camera supports multiple video formats including HDCVI, CVBS and other two common HD analog formats in the market. The four formats can be switched over through OSD menu or by PFM820 (UTC controller). This feature makes the camera to be compatible with most end users' existing HD/SD DVRs.

#### Multi-language OSD

OSD menu provides multiple image adjustments and function settings to meet the requirements of different monitoring scenes. The OSD menu includes configurations such as backlight mode, day/night, white balance, privacy mask and motion detect. The camera supports 11 languages for OSD menu, namely, Chinese, English, French, German, Spanish, Portuguese, Italian, Japanese, Korean, Russian and Polish.

#### Protection

With working temperature range of -40°C to +50°C (-40°F to 122°F), the camera is designed for extreme temperature environments. Supporting  $\pm 30\%$  input voltage tolerance, this camera suits even the most unstable power supply conditions. Its 4KV lightning rating provides protection against the camera and its structure from the effects of lightning.

**Technical Specification**

<b>Camera</b>	
Image Sensor	1/2.7 inch CMOS
Max. Resolution	2560(H)×1440(V)
Pixel	4MP
Scanning System	Progressive
Electronic Shutter Speed	PAL: 1/25s~1/100000s NTSC: 1/30s~1/100000s
S/N Ratio	>65dB
Min. Illumination	0.02Lux/F2.0 30IRE, 0Lux IR on
Illumination Distance	25m (82.0 ft)
IR On/Off Control	Auto; manual
Illuminator Number	2 (IR)
Pan/Tilt/Rotation Range	Pan: 0°~360° Tilt: 0°~78° Rotation: 0°~360°

<b>Lens</b>					
Lens Type	Fixed-focal				
Mount Type	M12				
Focal Length	2.8 mm; 3.6 mm				
Max. Aperture	2.8mm: F2.0 3.6mm: F2.0				
Field of View	2.8mm: H: 105°;V: 56°;D: 125° 3.6mm: H: 84°;V: 47°;D:104°				
Iris Type	Fixed iris				
Close Focus Distance	2.8mm: 0.7m(2.30 ft) 3.6mm: 1.1m(3.60 ft)				
DORI Distance	Lens	Detect	Observe	Recognize	Identify
	2.8 mm	49.8m (163.4 ft)	19.9m (65.3 ft)	10m (32.8 ft)	5m (16.4 ft)
	3.6 mm	64m (210.0 ft)	25.6m (84 ft)	12.8m (42 ft)	6.4m (21 ft)

<b>Video</b>	
Frame Rate	CVI: PAL: 4M@25fps; 1080P@25fps; NTSC: 4M@30fps; 1080P@30fps AHD: PAL: 4M@25fps; NTSC: 4M@30fps TVI: PAL: 4M@25fps; NTSC: 4M@30fps CVBS: PAL: 960H; NTSC: 960H
Resolution	4M (2560 × 1440); 1080P (1920 × 1080); 960 H (960 × 576/960 × 480)
Day/Night	Auto switch by ICR
BLC	BLC/HLC/DWDR
WDR	DWDR
White Balance	Auto; manual

Gain Control	Auto; manual
Noise Reduction	2D NR
Smart IR	Yes
Mirror	Off/On
Privacy Masking	Off/On (8 area, rectangle)

<b>Certifications</b>	
Certifications	CE (EN55032:2015, EN 61000-3-2:2014, EN 61000-3-3:2013, EN55024:2010+A1:2015, EN 55035:2017, EN50130-4:2011+A1:2014) FCC (CFR 47 FCC Part 15 subpartB, ANSI C63.4-2014) UL (UL60950-1+CAN/CSA C22.2 No.60950-1)

<b>Port</b>	
Video Output	Video output choices of CVI/TVI/AHD/CVBS by one BNC port
Audio Interface	Built-in Mic (-A)

<b>Power</b>	
Power Supply	12V ±30% DC
Power Consumption	Max 2.8W (12V DC, IR on)

<b>Environment</b>	
Operating Temperature	-40°C to +50°C (-40°F to 122°F);<95% (non-condensation)
Storage Temperature	-40°C to +50°C (-40°F to 122°F);< 95% (non-condensation)
Protection Grade	IP50

<b>Structure</b>	
Casing	Plastic
Dimensions	Φ97.1 mm × 93.0 mm (Φ3.82" × 3.66")
Net Weight	0.17 Kg (0.37lb)
Gross Weight	0.23 Kg (0.51lb)

**Ordering Information** | **Accessories**

Type	Part Number	Description	
4MP Camera	DH-HAC-HDW1400TRQP 2.8 mm	4MP HDCVI IR Eyeball Camera, PAL	
	DH-HAC-HDW1400TRQP 3.6 mm		
	DH-HAC-HDW1400TRQN 2.8 mm	4MP HDCVI IR Eyeball Camera, NTSC	
	DH-HAC-HDW1400TRQN 3.6 mm ;		
	DH-HAC-HDW1400TRQP-A 2.8 mm		
	DH-HAC-HDW1400TRQP-A 3.6 mm		
	Accessories	DH-HAC-HDW1400TRQN-A 2.8mm	4MP HDCVI IR Eyeball Camera, NTSC
		DH-HAC-HDW1400TRQN-A 3.6mm	
PFA13G		Junction Box	
PFB205W		Wall Mount Bracket	
PFA152-E		Pole Mount Bracket (For use with PFB205W)	
PFA130-E		Junction box	
PFM800-4K		Passive HDCVI Balun	
PFM321D		12V 1A Power Adapter	
PFM820 (Only 1080P and below are available)	UTC Controller		
PFM904	Integrated Mount Tester		

**Optional:**



PFA13G  
Junction Box



PFB205W  
Wall Mount Bracket



PFA152-E  
Pole Mount Bracket  
(For use with PFB205W)



PFA130-E  
Junction box



PFM800-4K  
Passive HDCVI Balun



PFM321D  
12V 1A Power Adapter



PFM820  
UTC Controller



PFM904  
Integrated Mount Tester

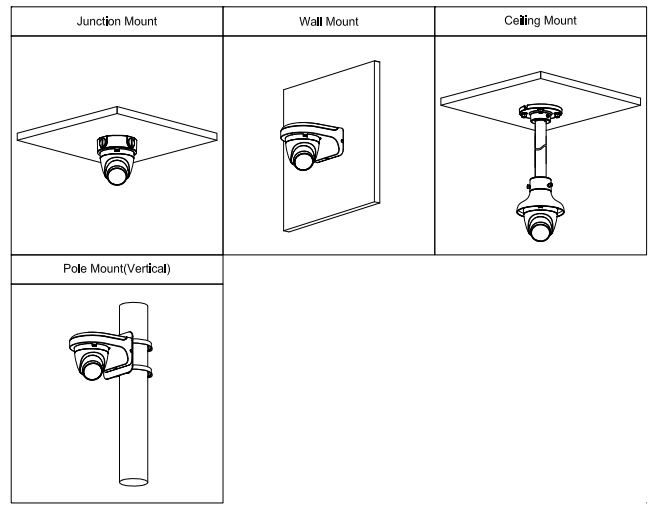

**Dimensions (mm[inch])**

